



About ZWCAD

ZWCAD is a cost-effective, DWG file format compatible CAD solution developed by ZWCAD Software Co., Ltd.. It provides innovative, collaborative and customizable features for engineers in the AEC and MCAD industries, easing their design process. Now ZWCAD is a proven CAD solution with over 320,000 satisfied users across 80 countries.

ZWCAD is now available in 15 languages, including Simplified and Traditional Chinese, Czech, English, French, German, Italian, Japanese, Hungarian, Korean, Polish, Portuguese, Spanish, Russian and Turkish.

Part of ZWCAD's Valued Customers



ZWCAD SOFTWARE CO., LTD.

Add: Rm. 508, No. 886, Tianhe North Rd., Guangzhou, 510635, China
Tel: +86-20-38259726 Fax: +86-20-38288676
E-mail: sales@zsoft.com

www.zsoft.com

ZWCAD Reseller

All trademarks, trade names or company names referenced herein are used for identification only, and belong to their respective holders.
Copyright 2008 - 2016 ZWCAD Software Co., Ltd. All rights reserved.
Reproduction in any form without the permission of the copyright holder is prohibited by law.

Your Proved Trusty CAD

Easy, Capable, Affordable

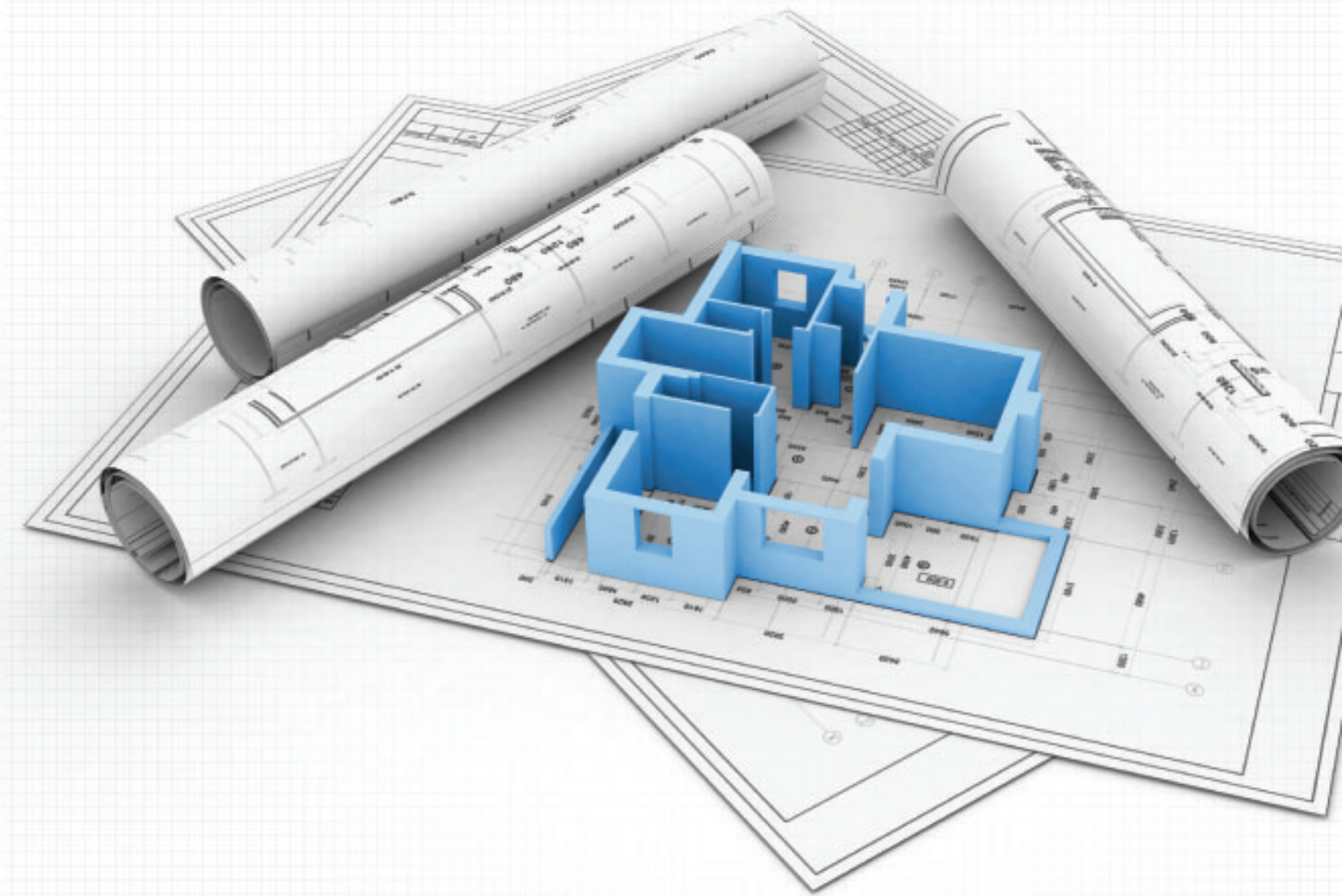

TOP REASONS TO CHOOSE ZWCAD

- ZERO relearning cost with easy-to-use functionality
- Efficient design tool like Render for productive drawing
- Seamless compatibility with DWG 2013
- Better value for your budget



ZWCAD Overview



ZWCAD is a cost-effective, DWG file format compatible CAD solution released by ZWCAD Software Co., Ltd to celebrate the 15th birthday of its flagship product ZWCAD, a proven CAD solution with over 320,000 satisfied users across 80 countries.

ZWCAD provides innovative, collaborative and customizable features for engineers in the AEC and MCAD industries, easing their design process.

Seamless compatibility with other CAD software

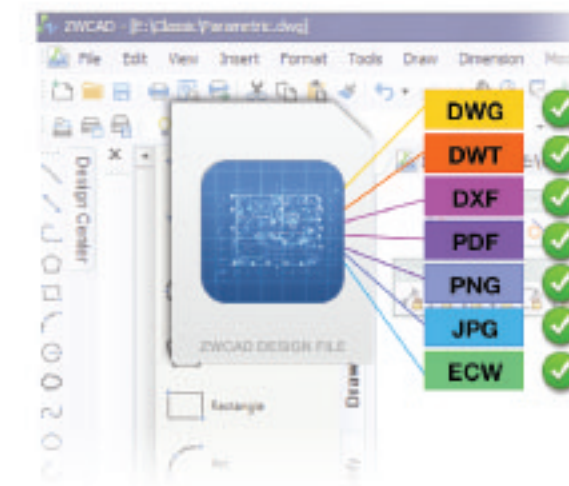

Having been through over 50,000 extremely rigorous drawing tests to guarantee seamless .dwg compatibility, ZWCAD makes cross-platform communication easier than before.



Zero relearning cost with easy-to-use functionalities

Similar commands to your previous program and easy-to-use features save you a lot of time and money as well as allow you to shift to ZWCAD within three days.



Better value for your money

ZWCAD helps to lower your budget. We never force annual upgrades to our customers because everyone has the freedom to choose the tools that they need. Also, there is only a one year upgrade fee from any previous version to the latest ZWCAD.



More and more people are using ZWCAD



"I am impressed with ZWCAD. With the combination of ease of use, DWG native format, feature rich commands, user interface, and affordable price point, it's looking like I may have just turned the corner and freed myself from an old way of thinking."

Ray Howard, CEO of CAD2BIM Solutions



"I sometimes consult on compatibility for competitors to Autodesk, and from this I have a collection of tough drawing with which to test DWG compatibility. Here ZWCAD scored excellent, displaying every test drawing correctly."

Ralph Grabowski, Managing Editor of Tenlinks.com



"ZWCAD has impressed me with its ease of use and accessibility to files. It's pretty intuitive and has all processes guiding users how to use the tools."

Fancisco Silva, Engineering Designer

Product introduction

All details created for your full design need



Before starting

Your most familiar CAD

Before starting

01

Your Most Familiar CAD

- DWG 2013 Support and Many More
- Friendly User Interface
- Customizable User Interface

Start from scratch

02

Visualize Your Idea

- Image
- Mleader
- Hatch
- Revision Cloud
- Table
- Field
- Block

Further your design

03

Tools Saving Your Time

- Solid Profile
- Tool Palettes
- Design Center
- Layer Properties Manager
- File Compare
- Breaking Dimension Line
- External Reference

Share it out

04

Make Collaboration Easy

- Plot
- Publish
- eTransmit
- Render

DWG 2013 Support and Many More

ZWCAD can open and write DWG/DXF 2013 and DWF files. It is fully compatible with other mainstream CAD software.

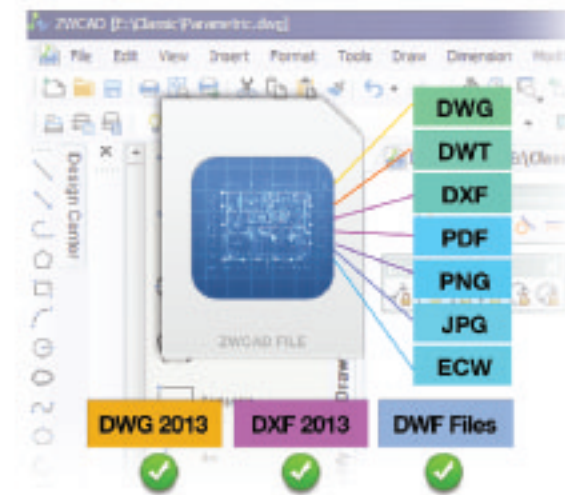

Friendly User Interface

The Windows-style user interface of ZWCAD arranges the menus, toolbars, command line, and dialog boxes in a way that is familiar to Windows users. This lets you begin working with ZWCAD right away. The Drawing tabs make it easy to switch between open drawings.



Customizable User Interface

You can customize your ZWCAD menu, commands, toolbars, hotkeys, and alias. ZWCAD is bringing you the most comfortable design environment for the most efficient work.

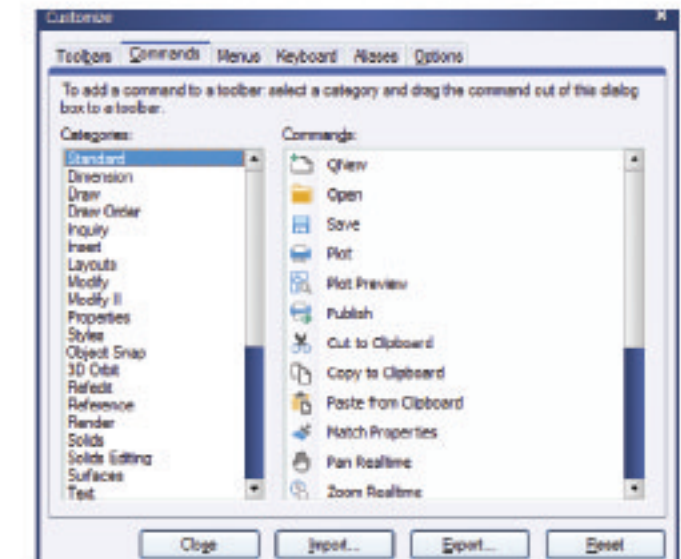

Start from scratch Visualize your idea

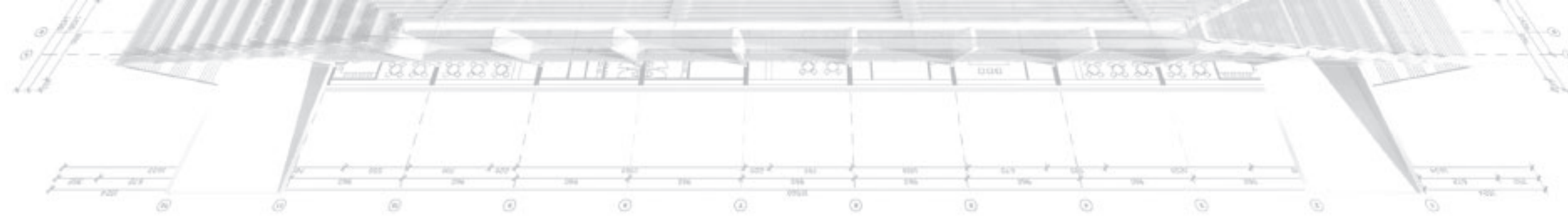

Image

Attaching raster image to your drawings better shows off your designs, ZWCAD supports numerous image formats, including BMP, TIF, GIF, JPG, PNG, PCX, TGA and ECW

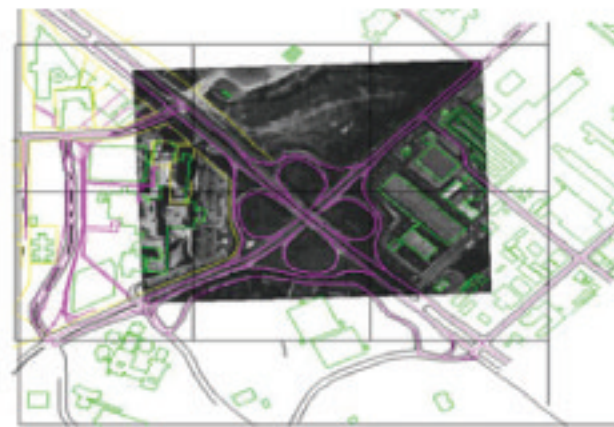

Hatch

Hatch fills in the enclosed area or object with a solid fill, gradient fill or a predefined hatch pattern. This makes the drawing vivid during a presentation. ZWCAD supports .pat files from other mainstream CAD software.

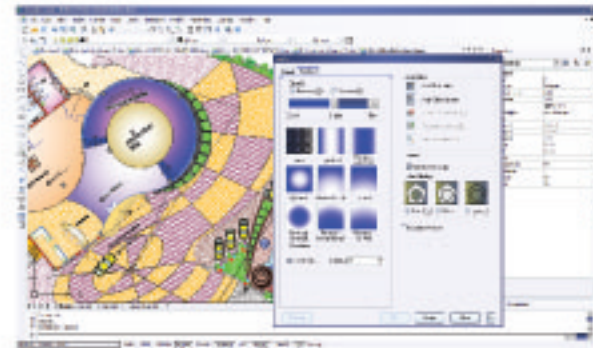

Field

Sometimes you need to update textual information in drawings. This painstaking task is solved with the field function. It updates information for you automatically.

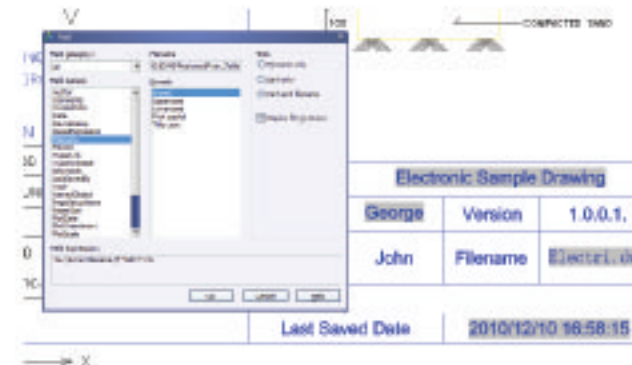

Block

The block function turns multiple objects into one, allowing you to standardize drawing components and reuse them in other drawings. Attribute blocks can embed any kind of textual information such as inventory numbers, prices, and multi-line detailed descriptions



Mleader

Multileader enables you to attach annotations to multiple leader lines. You can add a leader line to an existing multileader object or remove a leader from it very conveniently.

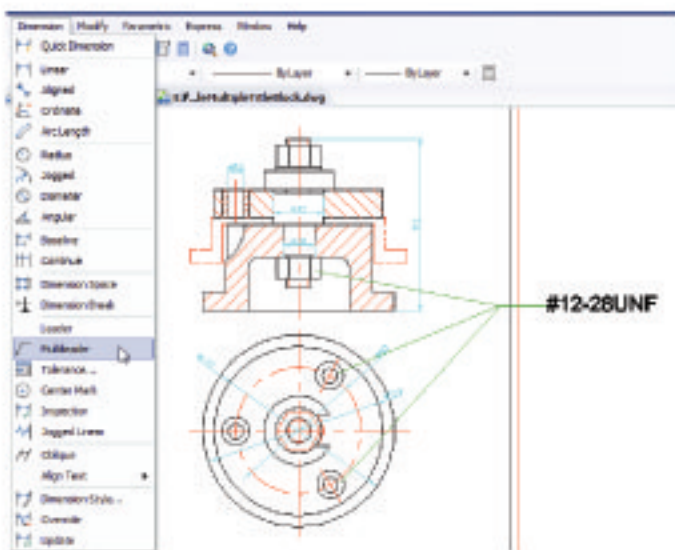

Revision Cloud

Revision cloud calls attention to the areas of a drawing that contain revisions. You can select the style of the revision cloud: Normal or Calligraphy, as well as convert objects to revision clouds, such as circles, ellipses or polylines.

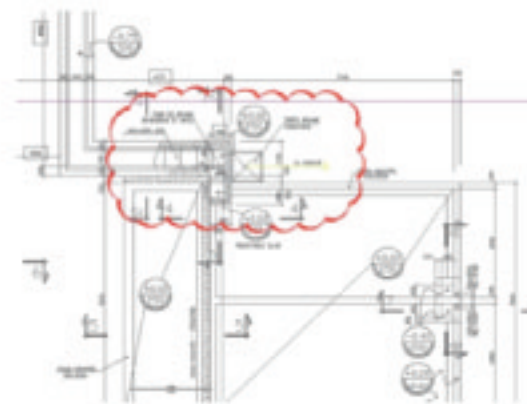

Table

The table feature lets you easily create neat tables just in a single step. In-place editing allows you to edit the contents of table cells, just as if you were working in Microsoft Excel. In addition, tables can export and import data files to and from Excel spreadsheets.



External Reference

Insert entire DWG files as external references. This lets everyone on your team collaborate together on big designs, yet won't increase the drawing file size by much.



Further your design: Tools saving your time

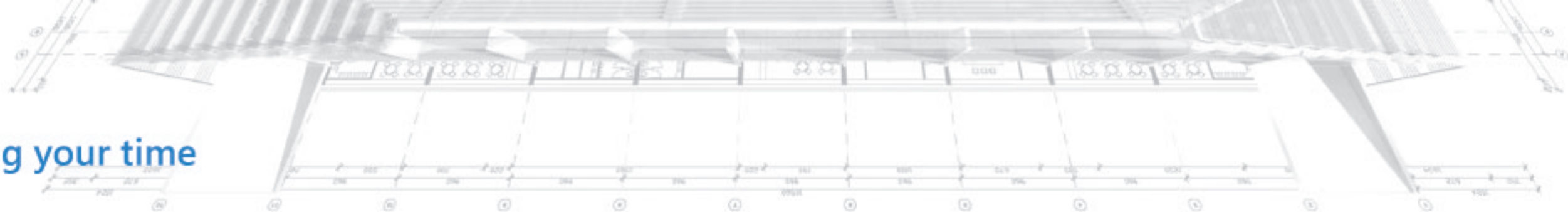

Design Center

The Design Center allows you to search and access any CAD resource stored on your computer or other computers on your local network. You can insert content in the current drawing, such as dimension styles, blocks, text styles, line types, and even layers from other drawings.

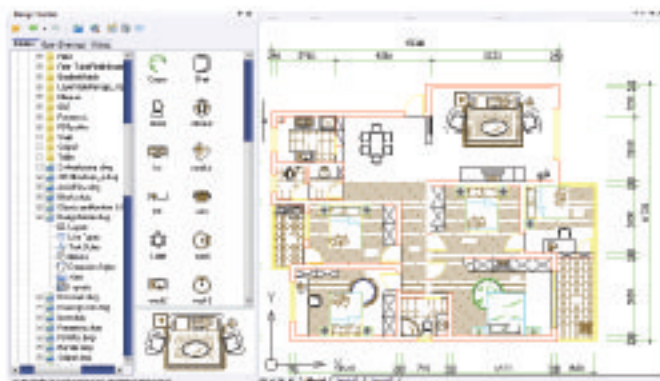

File Compare

File compare function helps you find differences between two similar-looking drawings. It highlights differences by color coding changed objects, blocks, and even external references. You can customize the comparison settings, such as colors and filters.

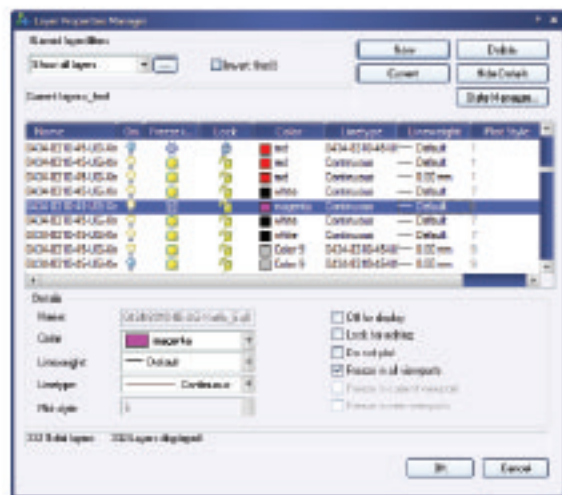

Layer Properties Manager

The Layer Properties Manager lists all the layers and their properties for batch processing. By editing the properties and applying changes in the manager, you will find the visual complexity of a drawing greatly reduced.

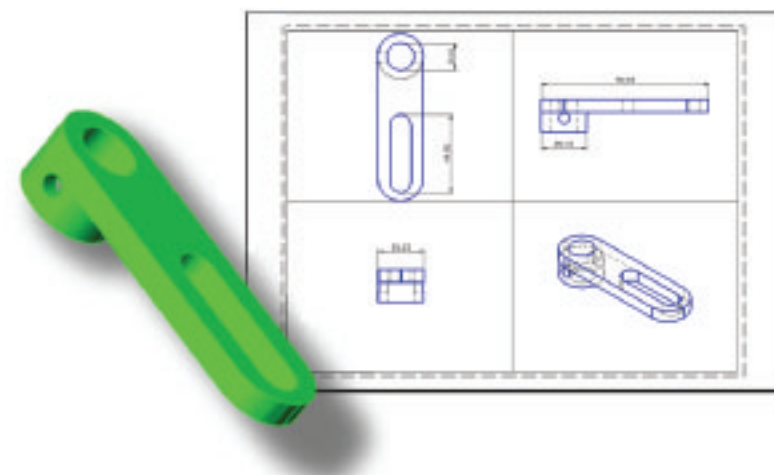

Solid Profile

The solid profile feature creates profiles of 3D solids with ease. You can specify 2D and 3D profiles. Hidden and visible lines are placed onto different layers automatically.

Tool Palettes

The Tool Palettes function provides an efficient way to organize, share, and store "tools," such as blocks, hatch patterns, entities, and even content from third-party developers.

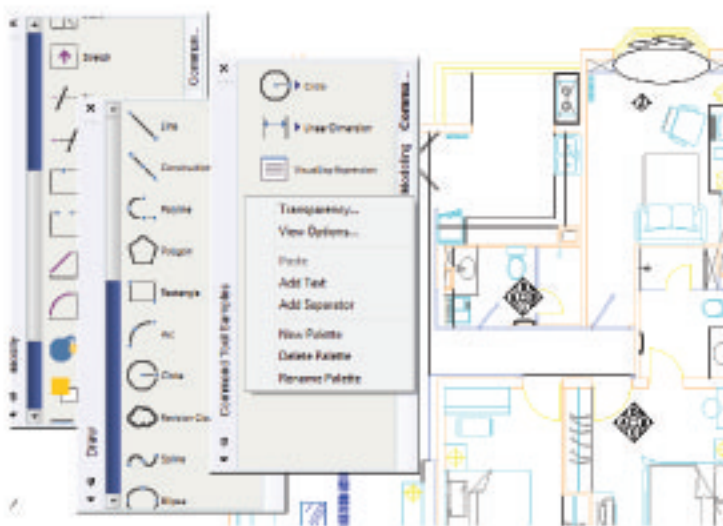

Breaking Dimension Line

Dimension break function breaks dimension lines where they cross other lines -- without splitting the lines, which make the drawing much more clear. And the broken dimension lines are still easy to adjust.

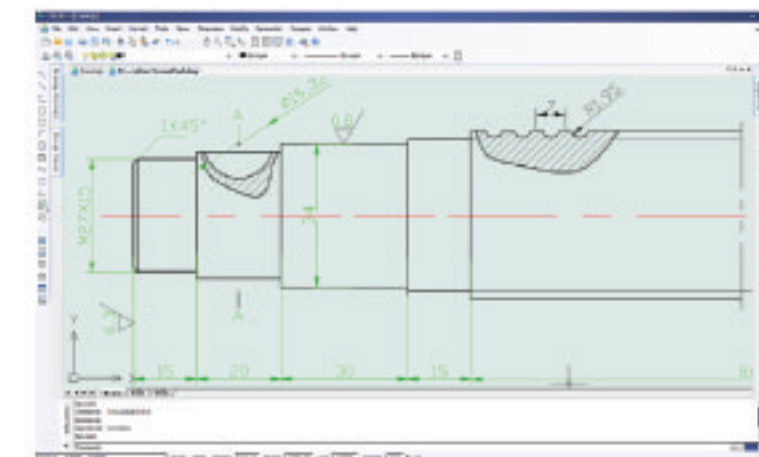

Share it out: Make collaboration easy

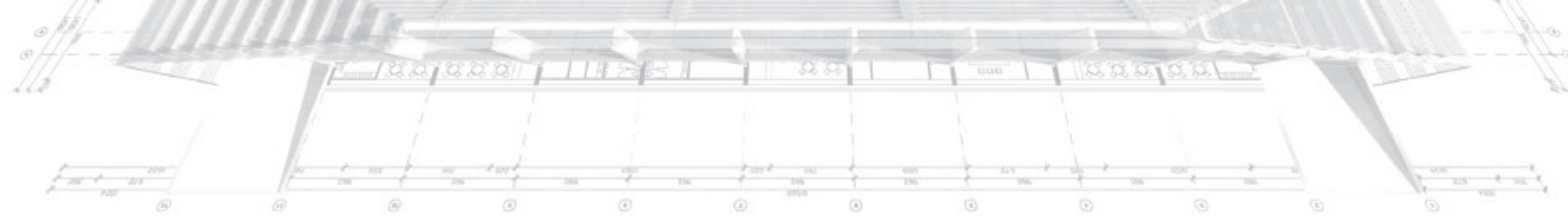

Render

Realistic renderings of 3D models produce more convincing presentations to clients than do 2D drawings. ZWCAD provides a rich variety of materials, multiple light types, and environmental settings to generate renderings. It is a good way to show off your design vision, and to verify it with others.

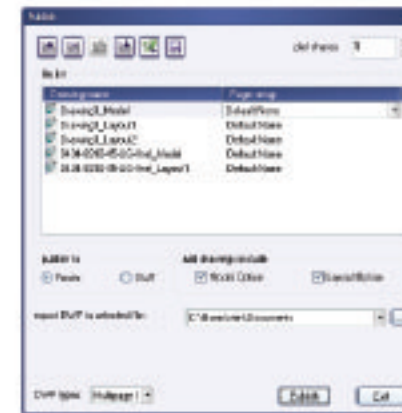

Publish

With Publish, models and layouts can be published to a single or multi-page DWF file or printer. This allows you to share drawings with coworkers or clients safely and quickly.

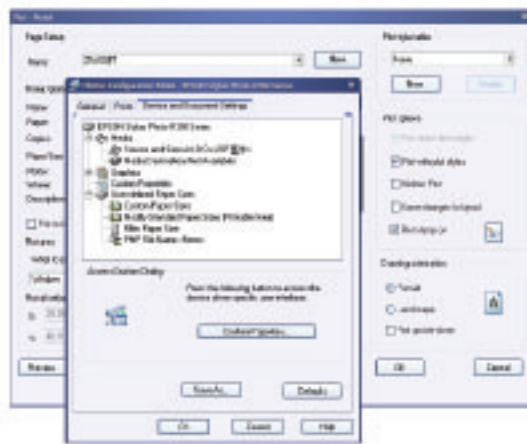

Plot

You can plot drawings to both files and paper. Multiple options can help you to fine-tune the results, including specifying the paper size, setting the plot scale, selecting a plot style, and adding a plot.

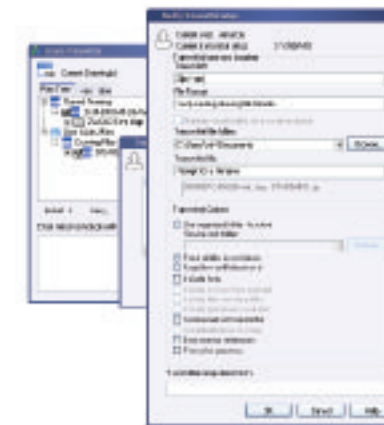

eTransmit

eTransmit improves collaboration between you and your clients. With a simple click, it collects all of the related drawings and support files and puts them into one package. The package includes the drawings, images, external references, fonts and other files you might want to attach.



Customer Voice

"We use ZWCAD to simplify design work and editing. A wide range of functions and licensing of the product allow us to work comfortably and without any problems. The functionality of ZWCAD certainly meets our requirements."

Jadwiga Sztelwander, Director of Deltamarin Poland



Customer Voice

"ZWCAD provides us a much faster processing and navigation over large projects. Together with a very competitive price for the organization, it really helps maintain and improve the quality of our work."

Guilherme, CIO of CASAIS Group

ZWCAD VS. ACAD

Features		Classic	LT	Full
Compatibility	DWF/DXF/DWT support	•	•	•
	DWG version 2.5 to 2013	•	•	•
Interface	Ribbon	•	•	•
	Palettes	•	•	•
	Menu and toolbar	•	•	•
	Command line	•	•	•
	Drawing tabs	•	•	•
2D drawing and editing	Fundamentals	•	•	•
	Entity Snap	•	•	•
	Polar tracking	•	•	•
	Multiple undo/redo	•	•	•
	Hatch & Gradient	•	•	•
	Region	•	•	•
	Revcloud	•	•	•
	Multiline	•	•	•
Annotate	Dimensions	•	•	•
	Quick Dimension	•	•	•
	Text and Mtext	•	•	•
	Text in-place editing	•	•	•
	Leader & Qleader & Mleader	•	•	•
	Table	•	•	•
	Field	•	•	•
Layer	Layer manager	•	•	•
	Layer filter	•	•	•
	Layer state	•	•	•
	Layer translator	•	•	•
Xref, Block and attribute	OLE	•	•	•
	Images	•	•	•
	Xref	•	•	•
	Block	•	•	•
Advanced	Attribute	•	•	•
	Design center	•	•	•
	Tool Palettes	•	•	•
	Group	•	•	•
	Quick Select	•	•	•
	Express tools	•	•	•
	Command prompt	•	•	•
3D	File compare	•	•	•
	3D Orbit	•	•	•
	3D modeling	•	•	•
	3D editing	•	•	•
	Visual styles	•	•	•
Output	Render	•	•	•
	Publish	•	•	•
	Plotting	•	•	•
	Export	•	•	•
	eTransmit	•	•	•
	Viewport	•	•	•
Programming	Layout	•	•	•
	LISP	•	•	•
	VBA	•	•	•
	ZRX, SDS	•		ARX

• Supported

Company Introduction

ZWCAD Software Co., Ltd. is an international CAD software provider through its network of 300+ partners in 80+ countries and regions. Its product ZWCAD is used by CAD designers across the AEC and MCAD industries.

Global Operations

ZWCAD Software Co., Ltd. is currently cooperating with 300+ partners worldwide. We believe that working together with our partners in the industry and sharing success is essential in today's business environment.



Global Partner Conference



Global Partner Conference Free Talk

